

SFERA 63 WC MONOBLOCCO | CASSETTA

CATALANO
THE ESSENCE OF CERAMICS

cod. 1MPSFR00

Wc monoblocco, scarico a parete trasformabile terra tramite curva tecnica non a corredo.
Monobloc WC outlet to wall. Commutable in outlet to floor by a pipe fitting, not included.

newflush®

Nuovo scarico senza brida.
New flush without rim.

cod. 1CMSFR00

Cassetta in ceramica con coperchio.
Ceramic cistern with lid.

cod. 5BASZ00

Batteria di scarico con dispositivo dual flush 3/4,5 lt.
Flushing battery with dual-flush device 3/4.5 lt.

CE EN 997 - CL1 - 6A

cod. 5KRBSZ00

Kit raccordo per alimentazione cassetta.
Pipe fitting kit for cistern feeding.

cod. 5CUIG00

Curva di raccordo per scarico a pavimento.
Connection elbow for floor outlet pipe.

 cod. 5S63STP00 Soft Close Plus*

 cod. 5S63STF00 Soft Close*



* TakeOff System

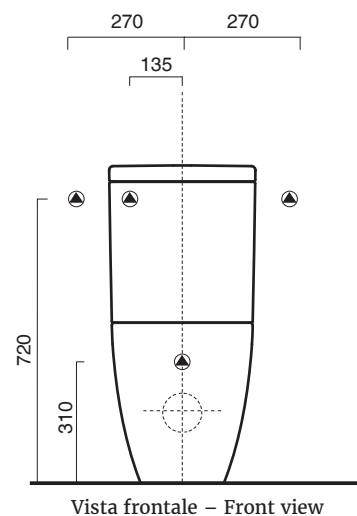
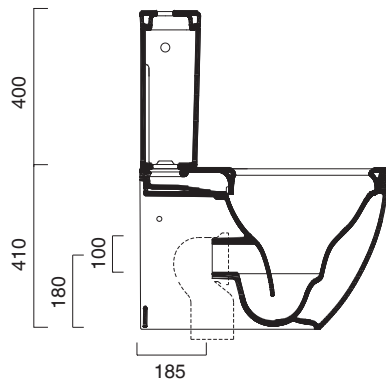
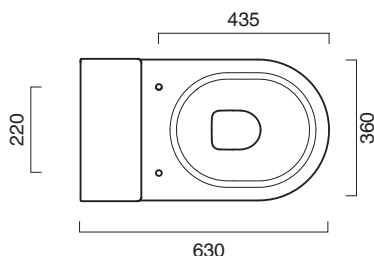

Tutti i diritti sulla presente scheda appartengono a Ceramica Catalano S.p.A. in via esclusiva. È vietata la copia, la pubblicazione, la distribuzione o la riproduzione (anche parziale), se non autorizzata per iscritto.
All rights in the present form belong exclusively to Ceramica Catalano S.p.A. It is strictly forbidden to copy, publish, distribute or reproduce it (including any partial reproduction), without prior written permission.



cod. 5CUIG00

Curva di raccordo per scarico a pavimento.
Connection elbow for floor outlet pipe.

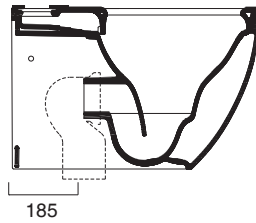

185



cod. 5CU0400

Set scarico regolabile da 60 a 145 mm
Adjustable discharge set from 60 to 145 mm

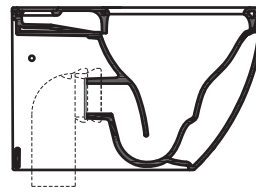

60-145



cod. 21150

Set scarico regolabile da 160 a 240 mm
Adjustable discharge set from 160 to 240 mm

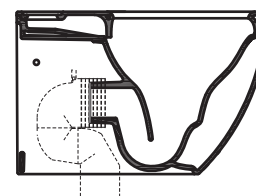

160-240

newflush®

over silent, over clean.



TRIPLE FLUSHING

Tramite flussi d'acqua tangenziali, incrementa il comfort del prodotto riducendo in modo sensibile la rumorosità delle operazioni di scarico.

Water flows with tangential trajectory to optimise flushign performance and to significantly reduce the sound of toilet flush.



RIMLESS

L'eliminazione della brida garantisce maggiore continuità delle superfici del wc permettendo azioni di pulizia più semplici e approfondite, con minore utilizzo dei detersivi.

The removal of the rim ensures visual continuity of the surfaces and allows for easier and deeper cleaning requiring less detergents.

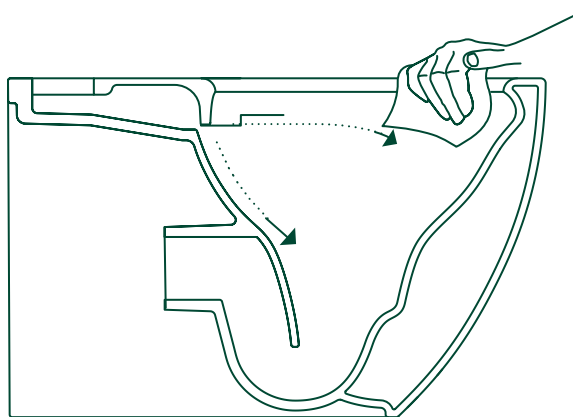
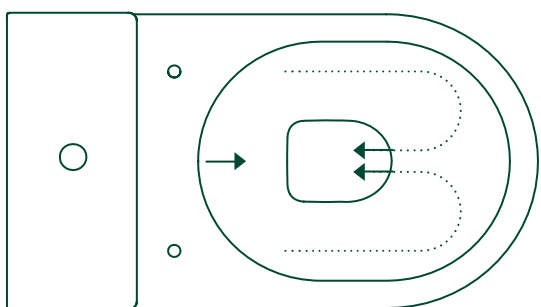

Newflush®



Traditionell Wc
Traditional Rim



CATAGLAZE



GLAZED SIPHON



HIDDEN FIXING SYSTEM



TAKE-OFF SYSTEM



SOFT CLOSE

MADE IN ITALY

GARANZIA

Il rivenditore sostituirà i prodotti con difetti di fabbricazione entro due anni dalla consegna.
Your retailer will replace products with faults of manufacturing within two years from delivery date.

PULIZIA

Si consiglia di pulire con acqua tiepida e detersivo non abrasivo.
The maintenance has to be done with tepid water and not abrasive detergents.

DICHIARAZIONE DI PERFORMANCE - DOP N° 997

Scarica il documento al seguente link a lato:
Click the link on the side to download the document:

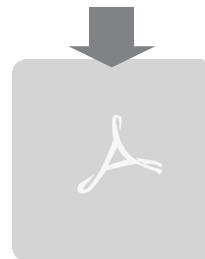

WATER LABEL

Una nuova etichetta informativa accompagna i WC Catalano, attribuita e certificata dalla The Water Label Company. L'etichetta mostra una classificazione di performance, indicando il volume massimo d'acqua che il wc utilizza nella fase di scarico.

All Catalano WCs have a new label, certified and issued by The Water Label Company. The label shows a performance ranking, indicating the maximum water volume of the toilet's flush.

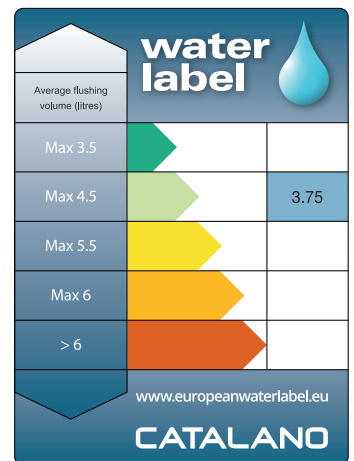

Antibacterial protection

CATAglaze[®] + Silver Titanium

CATALANO
THE ESSENCE OF CERAMICS

MADE IN ITALY

L'INNOVATIVO SMALTO ANTIBATTERICO SU TUTTA LA CERAMICA
THE INNOVATIVE ANTIBACTERIAL GLAZE IS STANDARD ON ALL
CATALANO PRODUCTS.

IT È un potenziamento dello smalto Cataglaze che, oltre a ridurre il deposito di calcare facilitando la pulizia dei sanitari ceramici, svolge una potente azione antimicrobica in grado di contrastare germi e batteri. L'efficacia della nuova formula è garantita dalla presenza nell'impasto di ioni d'argento e di titanio. L'azione antibatterica è certificata ISO 22196 con efficacia del 99,99%.

EN It is an improvement of Cataglaze glazing system; besides being more resistant to limescale and therefore easier to clean, it has a powerful antimicrobial action able to kill germs and bacteria. The effectiveness of the new formula is guaranteed by the presence in the mix of silver and titanium ions. The antibacterial action is ISO 22196 certified and it is 99.99% effective.



Silver Titanium
Protezione antibatterica
Silver Titanium
Antibacterial protection
Silver Titanium



99,99%

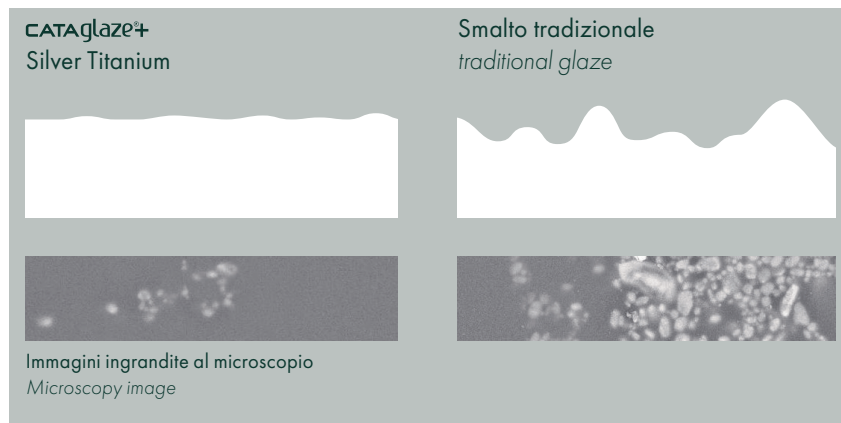

Maggiore brillantezza
Brightness



Resistenza agli agenti chimici
Resistance to chemicals



Rispetto per l'ambiente
Respect for the environment



Pulizia facile e rapida
Quick cleaning



Igiene totale
Total hygiene



Lunga durata di vita
Long lifecycle

Tutti i diritti sulla presente scheda appartengono a Ceramica Catalano S.p.A. in via esclusiva. È vietata la copia, la pubblicazione, la distribuzione o la riproduzione (anche parziale), se non autorizzata per iscritto. All rights in the present form belong exclusively to Ceramica Catalano S.p.A. It is strictly forbidden to copy, publish, distribute or reproduce it (including any partial reproduction), without prior written permission.